solutions for industry

#RaisingTheStandards

Gerflor[®]
theflooringgroup

contents



GERFLOR & INDUSTRY

Life Sciences
High Technology
Manufacturing

p 8

p 18
p 24
p 30



CLEANROOMS

Certified flooring
Solutions for wet areas
Renovation solutions
Corner system
Wall protection

p 36

p 40
p 42
p 44
p 46
p 48



ESD AREA - EPA / ATEX

ESD Flooring
Renovation solutions

p 50

p 54
p 56



HEAVY-TRAFFIC AREAS

Flooring
Wall protection

p 58

p 62
p 64



OFFICES & ADMINISTRATIVE AREAS

Flooring
Renovation solutions
Wall protection

p 70

p 74
p 76
p 78



SERVICES

Validation of chemical resistance
Showrooms
Recommended installation companies
Technical support
Custom floor solutions
Custom wall solutions
Watertightness control

p 84

p 86
p 87
p 88
p 89
p 90
p 93
p 94

GERFLOR PRESENCE EVERYWHERE...

SALES GROWTH

GERFLOR GROUP
TURNOVER

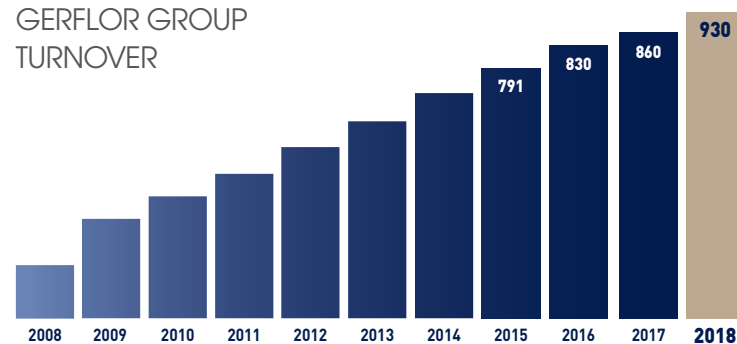

KEY FIGURES 2018

SALES

930 MILLION EUROS

STAFF

4 000 EMPLOYEES

WORLDWIDE PRESENCE

and proximity to our customers
through:



25 SUBSIDIARIES
AND A BROAD
NETWORK OF PARTNER
DISTRIBUTORS

16 MANUFACTURING
PLANTS AND LOGISTIC
HUBS

OUR VALUES

TEAMWORK

RESPECT AND INTEGRITY

ACCOUNTABILITY AND COMMITMENT

CUSTOMER SUCCESS

ENTREPRENEURSHIP AND AGILITY

6
MILLION

children daily enjoy
the benefits Taraflex™
Sports flooring



10
WORLD
CLASS

competition games played
every day on a Taraflex™
Sports floor.

100
MILLION

people daily live on
Gerflor Residential
flooring.



500
MILLION

patients treated
every day on Gerflor
floors for Healthcare.

600
MILLION

people daily travel on
Gerflor Transport
flooring



200 000 SQM

of Gerflor floor and wall protections
- 600 installed every day.

GERFLOR & THE ENVIRONMENT



1 HEALTHY AND CAREFULLY SELECTED MATERIALS

NO heavy metals
NO solvents
NO formaldehyde
NO substances potentially subject to REACH restrictions



2 ENERGY SAVINGS

A choice of colours with high reflectance values



3 ENVIRONMENTAL CERTIFICATIONS

Gerflor products satisfy and contribute to the requirements of the world's leading environmental certification standards.



GERFLOR

&

industry



80 YEARS of industrial Innovation

3 RESEARCH AND DEVELOPMENT CENTRES,
dedicated to product innovation, with 140 engineers
developing tomorrow's solutions in partnership
with our customers.

MIPOLAM EL5
First ESD floor

1985



1988

MIPOLAM
First vinyl floor

1937

GTI
First GTI tile, loose lay flooring
resistant to heavy traffic

**SPM WALL
PROTECTIONS**

2007



2008

**MIPOLAM
ELEGANCE
EL5**

Latest-generation conductive
flooring for EPA and
explosion-risk areas

**MIPOLAM
BIOCONTROL**
Certified Cleanroom floor

2009



GTI MAX

3rd generation
of GTI tiles with
the new GTI Max,
even more resistant
to heavy traffic

2012



**MIPOLAM
BIOCONTROL
PERFORMANCE**

Gerflor drives back the
boundaries of cleanroom
flooring

2016

**MIPOLAM
BIOCONTROL EL5**

First ESD floor certified for cleanroom

2018



2017

**GTI EL5
CONNECT/
CLEANTECH**

Complete system of quick-
fitting ESD flooring

2015

**CLEAN CORNER
SYSTEM**

Cleanroom corners boasting
superior versatility

2010

**GERFLOR CORNER
SYSTEM**

First Cleanroom corner system

A fully dedicated GERFLOR team, supporting the manufacturer.

Our dedicated team provides specific advice thanks to GERFLOR's expertise in industrial problems and the associated regulations around the world.

GERFLOR is a member or partner of the most respected professional associations:



GERFLOR is an active contributor to reference works on the creation of cleanrooms:

- ASPEC "Envelope" Guide
- "Ultra Propreté" ultraclean guide

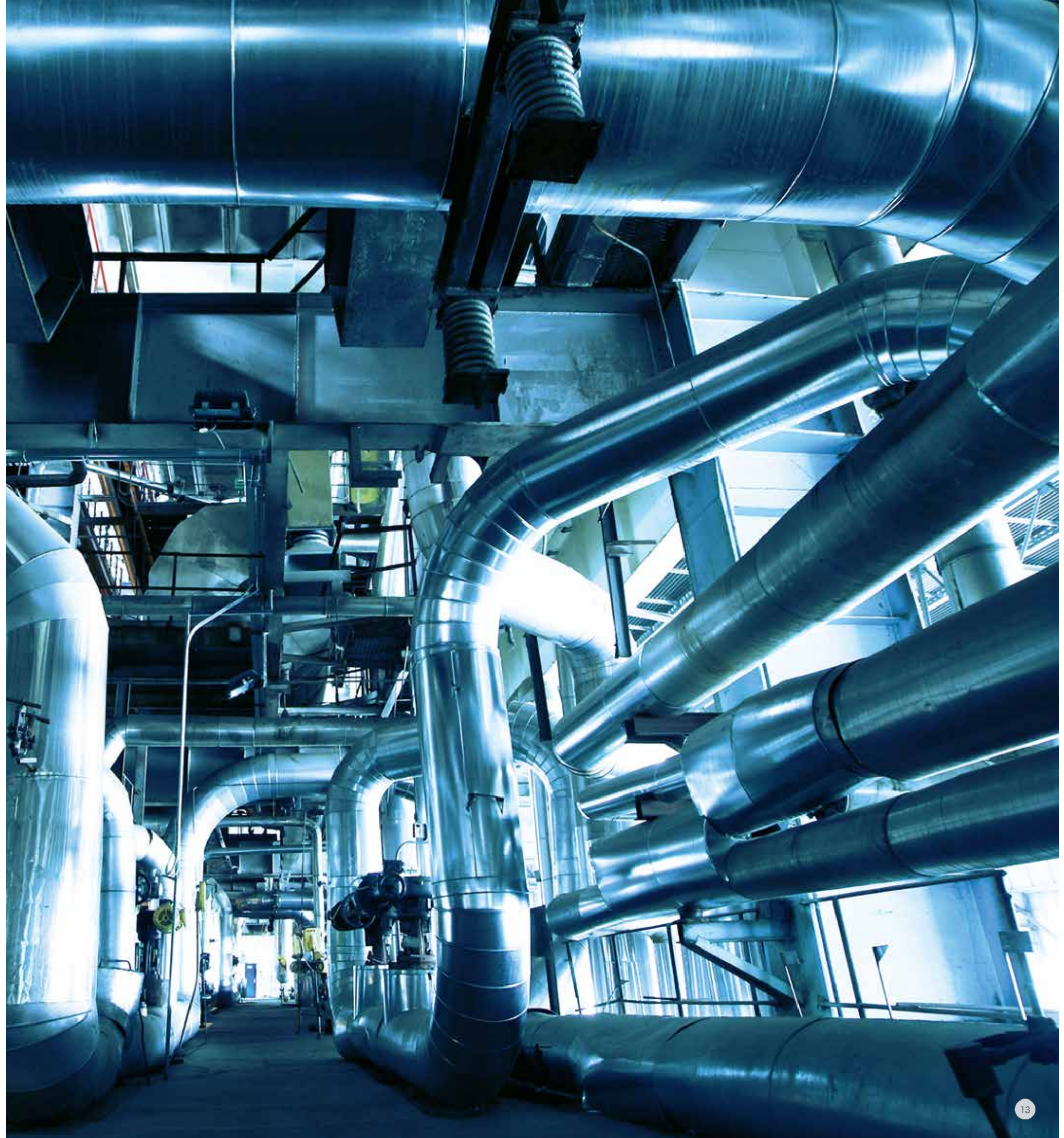

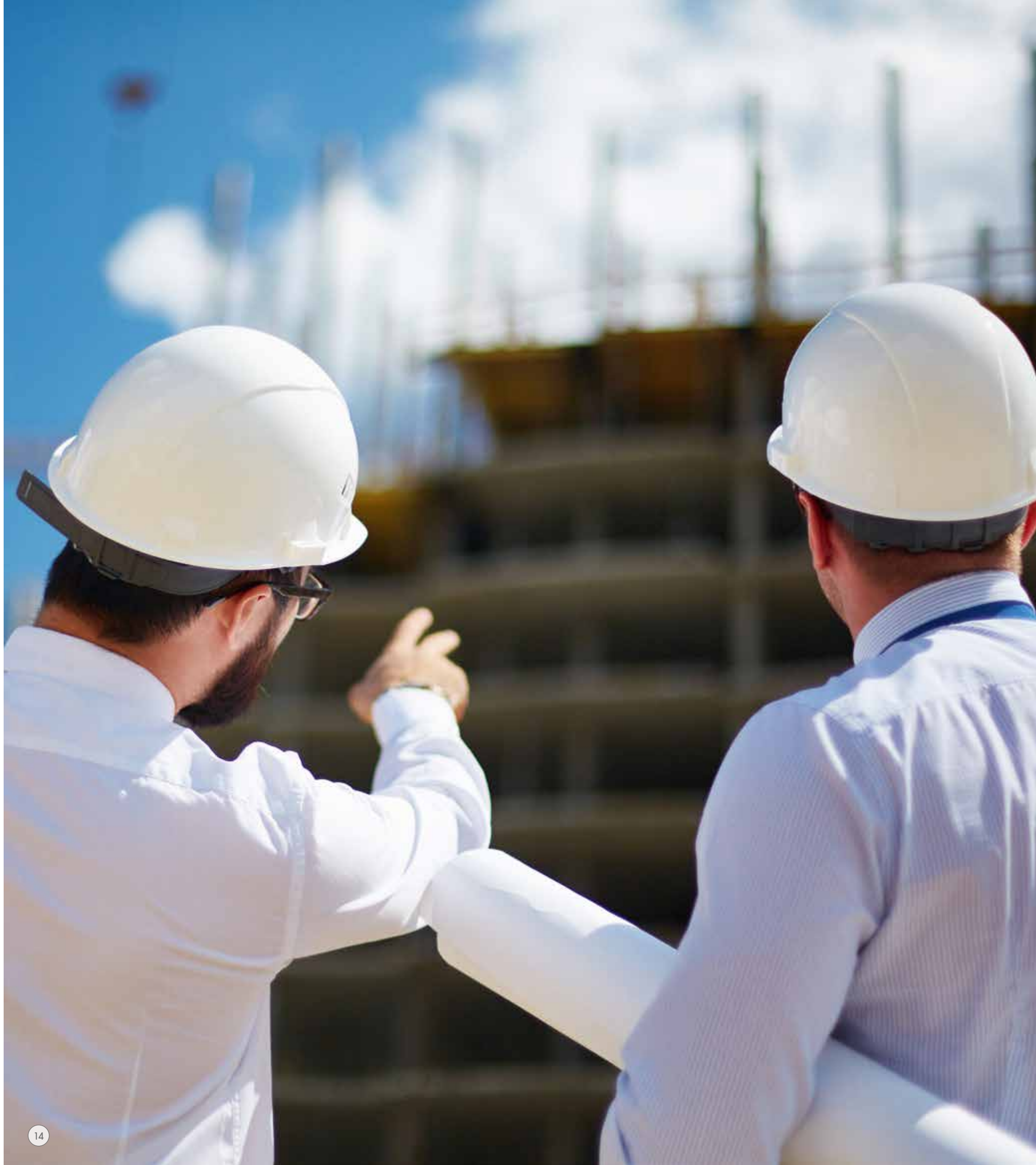

Support throughout
your project and much
more besides

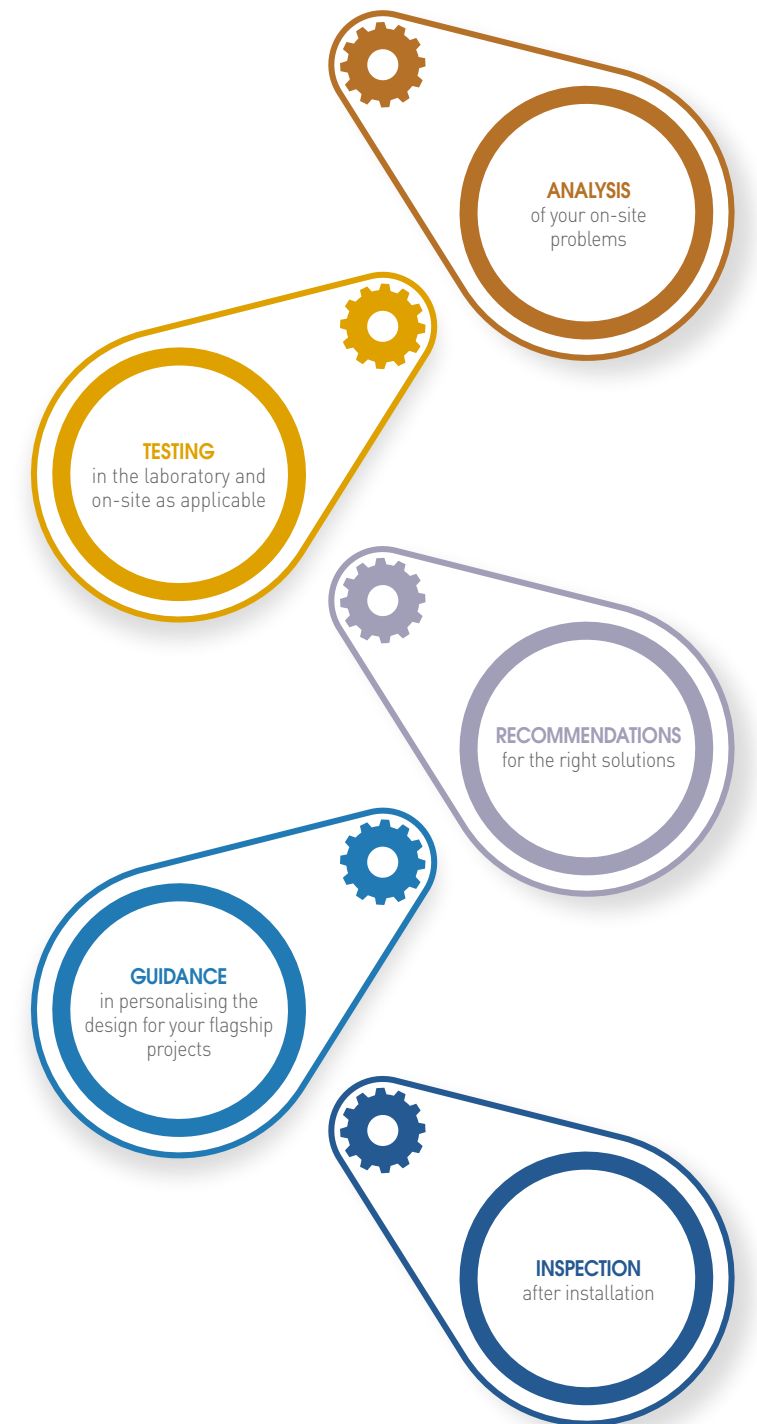



Our commitment:

Guarantee the **SAFETY, QUALITY** and **RELIABILITY** of our customers' production facilities.



80 years' experience servicing industrial customers

This experience has allowed GERFLOR to develop dedicated solutions, from cleanrooms to unloading docks, for every type of industry:

● **LIFE SCIENCES:**
pharmaceuticals, biotechnologies, cosmetics, food...



● **HIGH TECHNOLOGY:**
aerospace, electronics, optics...

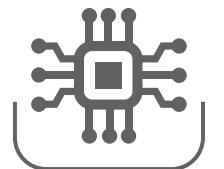

● **MANUFACTURING:**
automotive, plastics, paper, textile...

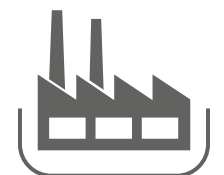



LIFE SCIENCES



The specifics of the life sciences industry

STANDARDS

To guarantee production quality, manufacturers in the life sciences industry (pharmaceuticals, cosmetics, etc.) need to comply with various standards and regulations, and to Good Manufacturing Practices (GMP):

- ISO 14644-1 Classification of air cleanliness
- ISO 14644-8 Control of molecular contamination
- ISO 14698-1 Control of biocontamination

To comply with them, manufacturers must use special facilities to control the production environment: cleanroom.

The constraints can vary depending on the activity and are classified as follows:

- CLASS A, B, C or D for industries subject to GMP
- ISO 4, 5, 6, 7, 8, 9 for the rest (formerly class 10, 100, 1000...)

	GMP CLASS	A	B	C	D
Particle concentrations at rest	Maximum number of particles (d < 0.5 µm) per m ³	3 500	3 500	350 000	3 500 000
	Maximum number of particles (d ≥ 5 µm) per m ³	0	0	2 000	20 000
Particle concentrations when active	Maximum number of particles (d < 0.5 µm) per m ³	3 500	350 000	3 500 000	Depends on type of activity
	Maximum number of particles (d ≥ 5 µm) per m ³	0	20 000	20 000	
Microbiological contamination (recommended limits when active)	Air: cfu/m	< 1	10	100	200
	Petri dish 90mm diam: cfu/4 hrs	< 1	5	50	100
	Agar 55mm diam: cfu/plate	< 1	5	25	50
	Glove print (5 fingers): cfu/glove	< 1	5	-	-

CONTAINMENT AREAS

Zones that are subject to GMP, cleanrooms and similar areas are normally required to protect the products made there.

But there are also containment facilities whose purpose is to protect the outside world and researchers from the products handled in those zones.

They are classified by type and according to the level of biological safety (BSL): L1, L2, L3, L4 (high-security laboratory)



GERFLOR SOLUTIONS ARE DESIGNED AND TESTED TO MEET THOSE REQUIREMENTS

The formulations of GERFLOR products limit the emission of controlled particles and molecules when subject to temperature differentials. Compacting reduces the microroughness of surfaces to limit the adhesion of particles and microorganisms.



ULTRA CLEAN

- GERFLOR products are smooth, rot-proof, non-absorbent, watertight and non-porous.
- Heat-welded smooth seams to avoid any level difference (floor-floor, floor-wall...) Weld and surface-integrity controls ensure the quality of the installation.



WATERTIGHTNESS

Exclusive installation solutions ensure a perfect seal across the entire surface of the fitted zone:

- covings,
- hot-welding,
- easy-fit corners,
- control of welding and surface integrity



EASE OF CLEANING AND DECONTAMINATION

Factory-applied surface treatments:

- does away with the need to apply acrylic emulsion for the **lifetime of the product**
- offer **high resistance to decontamination products** (hydrogen peroxide, peracetic acid, etc).
- And, combined with GERFLOR installation, enable a great **ease of maintenance**.



DURABILITY

- GERFLOR solutions are particularly **wear-resistant and withstand** impacts from carts and other tanks in pharmaceutical production units.
- The quality of the factory-made products -- using a tightly controlled production process -- does not depend on operating conditions nor on the installer's competence.



A GLOBAL SOLUTION FOR EACH AREA OF YOUR INDUSTRY

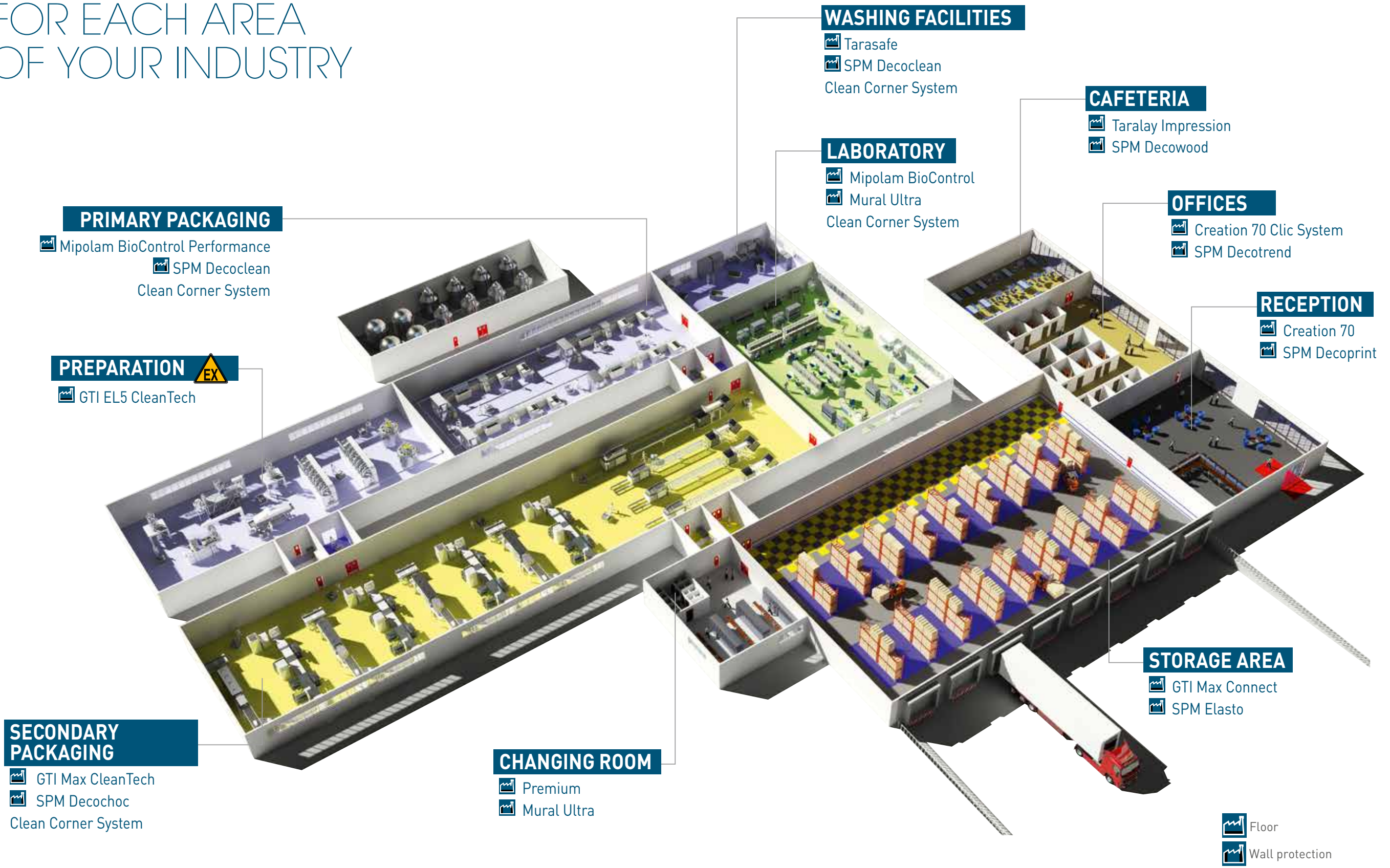

A selection of our clients:

Cosmetics - Biotechnology - Pharmaceuticals - Medical Devices - Veterinary Supplies - Food Production - Safety Labs



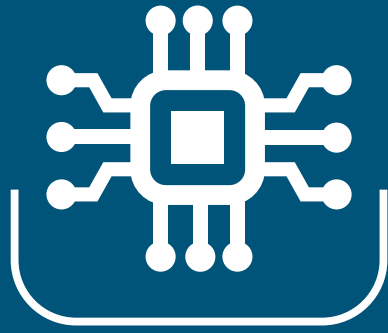

HIGH TECHNOLOGY

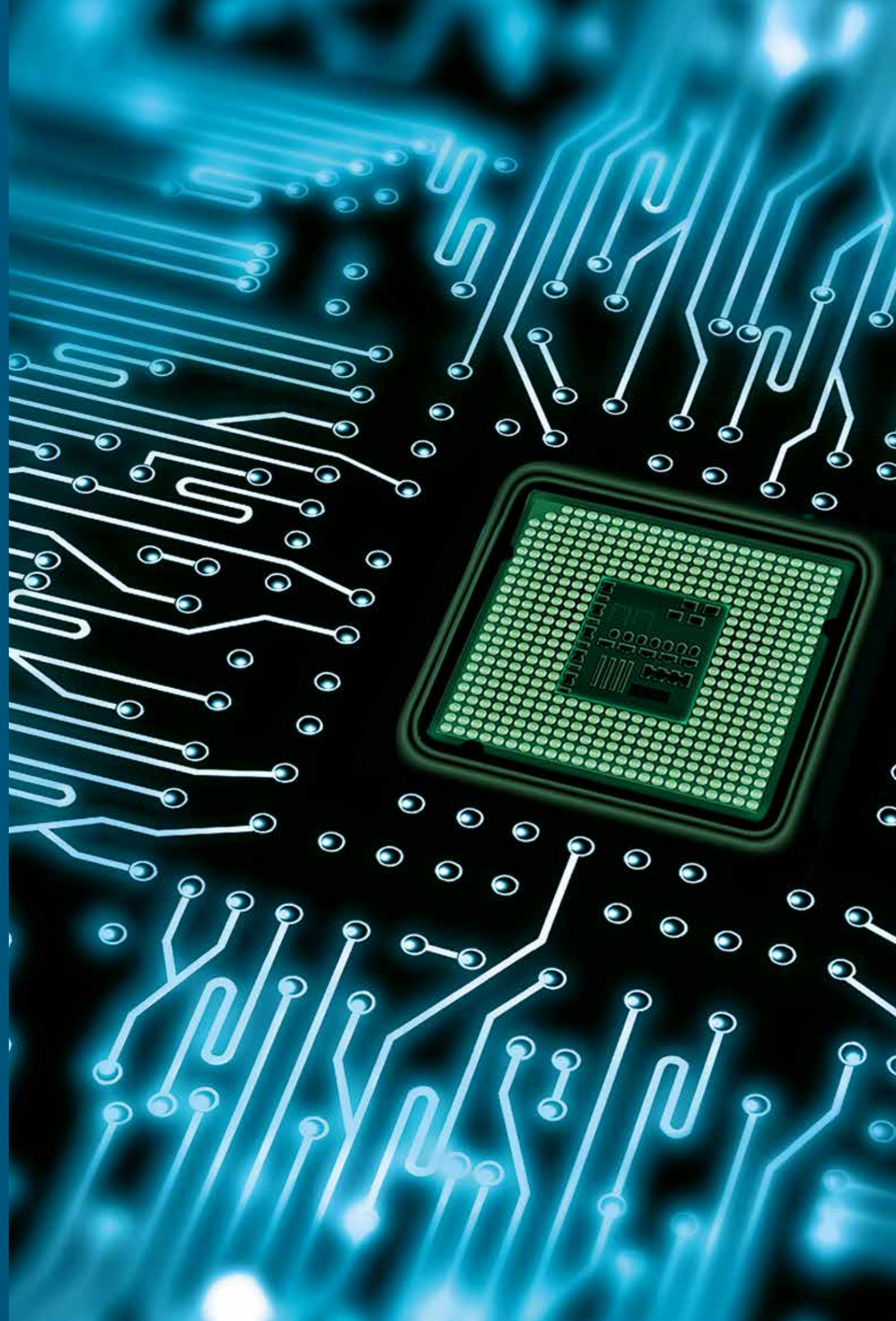

The specifics of the high technology industry

To maximize the quality of manufactured products and to ensure personal safety, the electronics, optoelectronics and nuclear industries not only follow cleanroom procedures but also comply with the protection standards for electronic and electrical devices against electrostatic discharges (ESD):

- IEC/EN 61340-5-1
- ANSI/ESD S20.20

The elimination of electrostatic discharges at source by using ESD flooring is an effective solution for limiting risk of electrostatic discharges.



Logo on the floor to indicate an EPA*

*EPA = ESD Protected Area

GERFLOR SOLUTIONS PREVENT ESD RISKS SO THEY CAN BE INSTALLED IN EPA*

*ESD Protected Area

GERFLOR controls all the parameters and standards that, when combined with quality ESD shoes, enable the floor to:

- LIMIT THE ACCUMULATION OF STATIC ELECTRICITY**
 - IEC/EN 61340-4-5
 - ANSI/ESD STM 97.2
- EFFICIENTLY ELIMINATE ELECTROSTATIC CHARGES**
 - IEC/EN 61340-4-5 and IEC/EN 61340-4-1
 - ANSI/ESD STM 97.1 and ANSI/ESD S 7.1

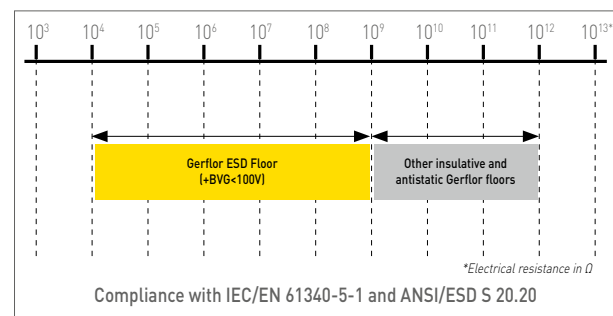

GERFLOR offers a comprehensive range of ESD floorings that let you:

- PROTECT ELECTRONIC EQUIPMENT AND COMPONENTS** from the risk of electrostatic discharges (EPA*)
- PROTECT PEOPLE** from the risk of electrostatic discharges
- PROTECT PREMISES** from the risk of explosion (ATEX area)

THE ESD PHENOMENON IN CONVENTIONAL ENVIRONMENTS

To ensure the best possible ESD-free work environment, all GERFLOR flooring solutions feature an antistatic design (charge potential less than 2 kV according to EN 1815).



A GLOBAL SOLUTION FOR EACH AREA OF YOUR INDUSTRY

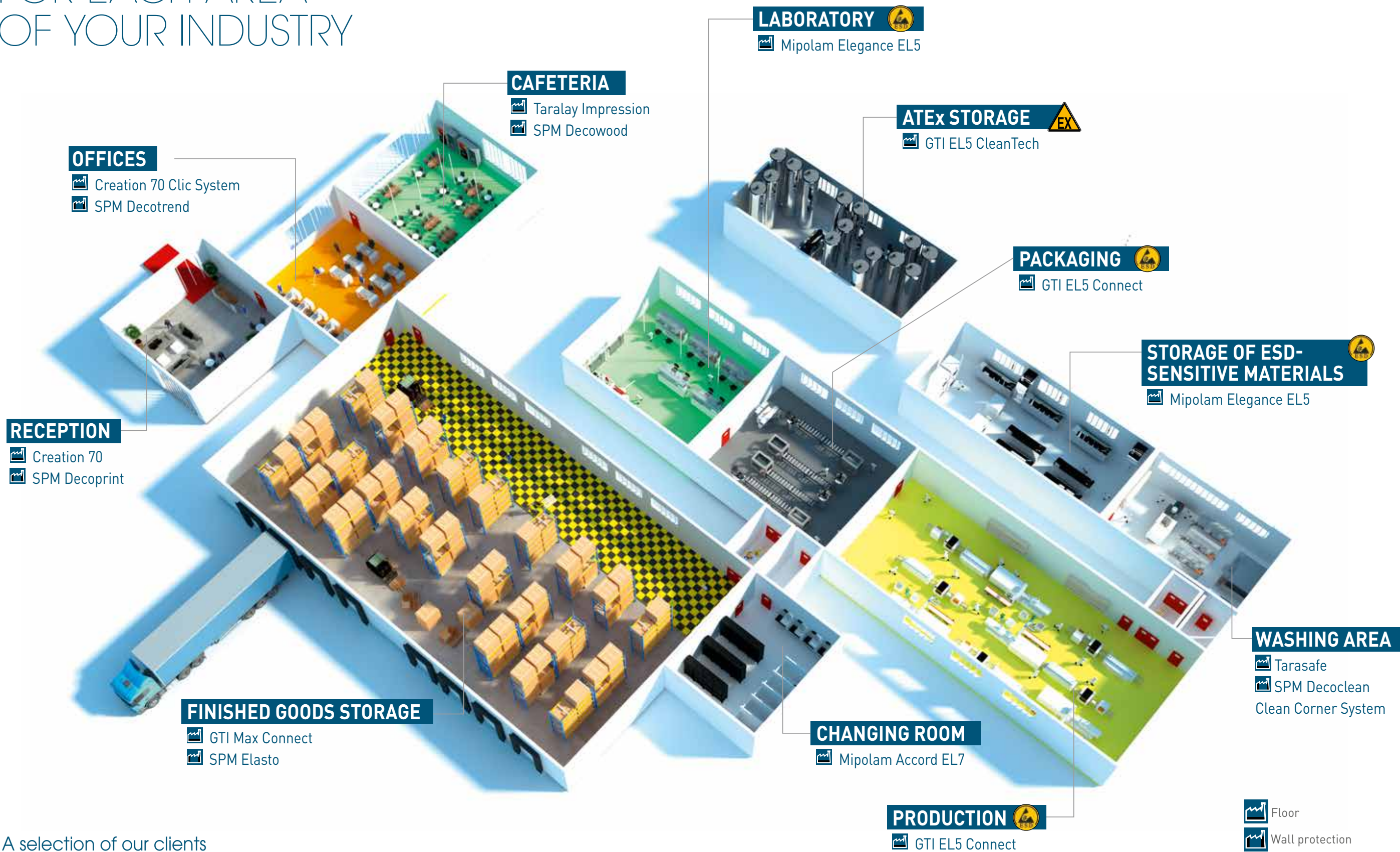

A selection of our clients

Electronics - Optics - Nuclear - Aerospace - Defence - Photovoltaic - Aeronautics



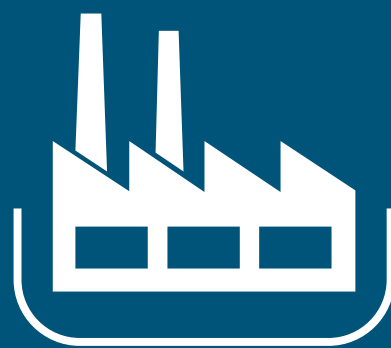

MANUFACTURING



The specifics of the manufacturing industry

In order to evolve in today's competitive markets, manufacturers must demonstrate their capacity to improve the productivity and quality of their products and services.

COMPLIANCE WITH STANDARDS

To have their products and services accepted in domestic and international markets, industries must comply with a certain number of standards, such as ISO 9001 for quality management.

QUALITY

Manufacturers apply quality management procedures intended to improve their productivity, the performance of their products, and customer satisfaction: 5S for example.



SAFETY

Safety is regulated (OHSAS 18001). It is aimed at improving productivity and protecting persons and property. This anticipation is integrated into the design and installation of the premises and means of production.

COMFORT

This idea of workplace comfort is subjective and must form part of a deliberate initiative to improve productivity. It covers the following topics:

- ergonomics
- the design of workstations
- human fatigue
- auditory comfort
- visual comfort

All these ideas require the right design and the right equipment on the premises and at the workstations.



GERFLOR SOLUTIONS SATISFY ALL THE REQUIREMENTS OF AN INDUSTRIAL ENVIRONMENT



FACILITATING PRODUCTIVITY

Loose-laid floors offer fast and easy installation



ENSURING QUALITY

• Controlled Hygiene

GERFLOR floorings and wall panels are rot-proof, non-absorbent, watertight, non-porous, and reduce bacterial growth.

• Ease of maintenance

Our products benefit from factory-applied surface treatments to prevent dirt retention and incrustation.

• Durability

Thanks to their flexibility and their resistance to scratching and abrasion, GERFLOR solutions can be used without the material cracking or breaking (in normal use conditions).

Factory-made material, the quality of our floorings is known and controlled.



ENSURING SAFETY

• Design of work zones

- Numerous possibilities for marking and zoning by colour coding and logos

• Protection of employees

- Non-slip products against risk of falling
- ESD products against electrical risks

• Protection of premises and equipment

- Solutions for ATEX area



IMPROVING COMFORT AT WORK

• Improvement of working conditions

- Reduces noise nuisance
- Comfortable to walk on and stand on
- Antistatic, no «heavy legs» syndrome
- No unpleasant odour
- Thermal insulation
- Range of colours to improve visual comfort at work



A GLOBAL SOLUTION FOR EACH AREA OF YOUR INDUSTRY

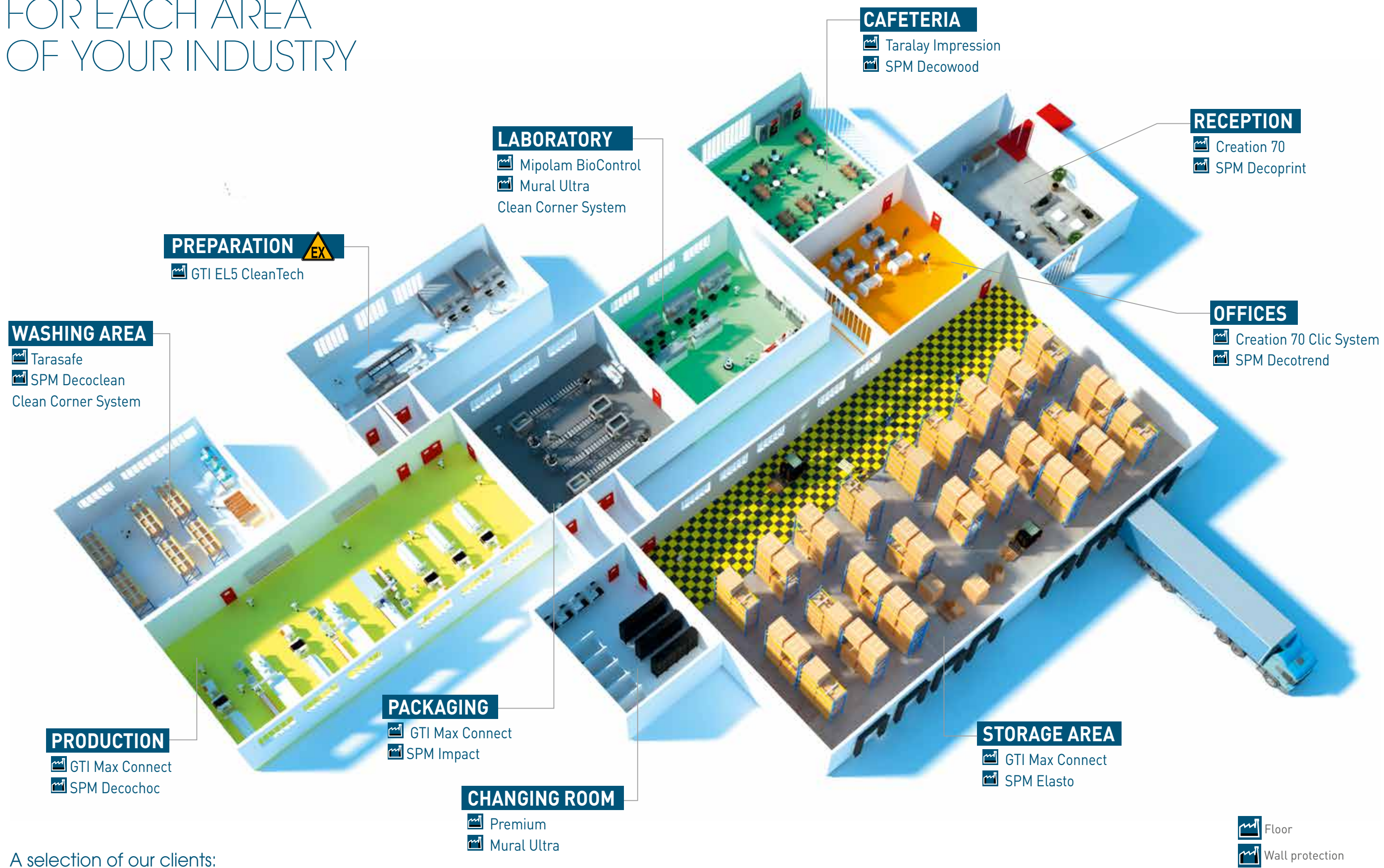

A selection of our clients:

Automotive - Mechanical - Papermaking - Textiles - Plastics Processing - Printing



CLEANROOMS

KEEP YOUR ENVIRONMENT
UNDER CONTROL

YOUR REQUIREMENTS

- Compliance with ultra clean standards (ISO, GMP*...)
- Moderate to heavy traffic
- Cleaning and regular decontamination
- Resistance to chemical attacks

* GMP: Good Manufacturing Practices



OUR GLOBAL SOLUTION

1

CERTIFIED FLOORING

- Mipolam BioControl range p.41
- **Solutions for wet areas:**
Tarasafe p.43
- **Solutions for renovations:**
GTI Max CleanTech p.45

2

CORNER SYSTEM

- Clean Corner System p.47

3

WATERTIGHTNESS CONTROL

p.98

4

WALL PROTECTION

- SPM Decoclean p.49
- Mural Ultra p.49

5

CUSTOM SOLUTION

- Logo p.92



CERTIFIED FLOORING

ISO standards, like GMP, require Life Sciences manufacturers to manage contamination levels, continuously over time, and be audited regularly by competent bodies for compliance.

GERFLOR has therefore developed a range of Mipolam flooring adapted to these normative and regulatory requirements for cleanroom production.

CLEANROOMS



MIPOLAM BIOCONTROL RANGE

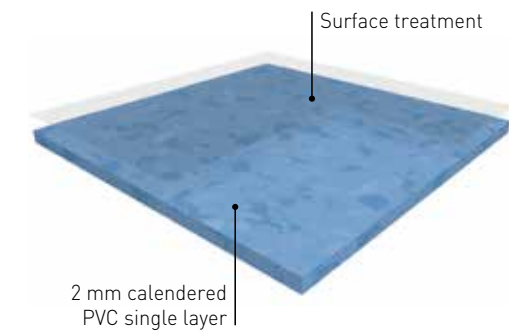

CLEANROOMS



THE + TOP-OF-THE-RANGE CLEANROOM FLOOR COVERING

ISO3 IMPACT ON PRODUCTION ENVIRONMENTS

- **Particulate cleanliness:**
ISO3 from the standard ISO 14644-1
- **Electrostatic cleanliness:**
Insulating and antistatic floors in accordance with EN 1081 and EN 1815

RESISTANCE TO COMMON DAMAGE IN CLEANROOMS

- **Resistance to microbiological damage:**
bacteriostatic
- **Resistance to chemical damage:**
more than 100 products tested
- **Resistance to heavy loads:**
up to 5MPa i.e 500T/m²

CLEANING & DECONTAMINATION

- **Particulate cleanability**
ACS of 98.6%
- **Microbiological cleanability**
GMP Class A (tested with A.Niger and E. Coli)
- **Resistance to bio-decontamination processes**
Compatible with regard to liquid and vaporised hydrogen peroxide

MIPOLAM BIOCONTROL EL5

- Specifically designed for ESD and ATEX areas

FLOORINGS

WET AREA SOLUTIONS

For safety reasons, some rooms can require higher non-slip values than standard (R9 according to DIN 51130).

This is true of washrooms, showers and other rooms where standing water forms in everyday use, or in the agri-food industry in general where liquid, powder or oil is regularly present on the floor.

To meet these requirements and adapt to varied configurations, GERFLOR has developed a range of non-slip floorings.

Due to their extreme resistance, these products are also suitable for animal facilities where the flooring must be able to withstand substantial scratches.



TARASAFE

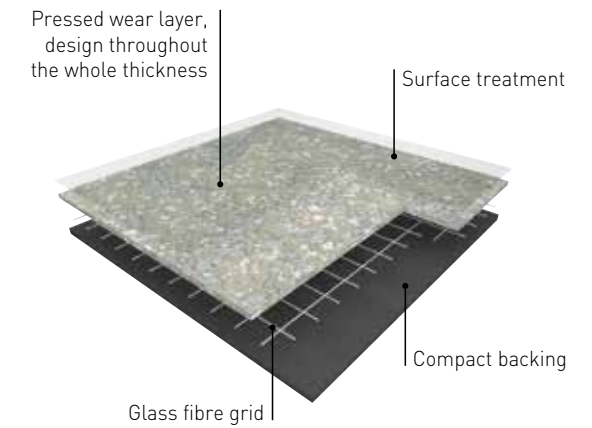

THE + PROTECTION AGAINST FALLS

SAFETY

● Non-slip - R10

EASY MAINTENANCE

● Resistant to staining and chemical aggression

RESISTANT TO MECHANICAL IMPACTS, indentation and extremely scratch-resistant

TARASAFE PLUS

● Non-slip and **safe** - R10

● Fabric base for **easy laying** in tricky conditions (high moisture levels)

TARASAFE SUPER

● High non-slip and **safety values** - R12

FLOORINGS

RENOVATION SOLUTIONS



WHY CHOOSE LOOSE-LAY FLOORING FOR RENOVATING YOUR CLEANROOMS?

The subfloor is unsuitable for gluing

- Contaminated floor: presence of hydrocarbons...
- Damp floor slab
- Cracks or blisters (blow-moulded resin)
- Old floor covering

The renovation time must be reduced to a minimum

- Short production downtime
- Presence of heavy loads that quickly damage the floor

Reduce on-site pollution

- Particulate-sensitive activities
- Molecular-sensitive activities



BEFORE



AFTER



GTI CLEANTECH RANGE



GTI EL5 CLEANTECH

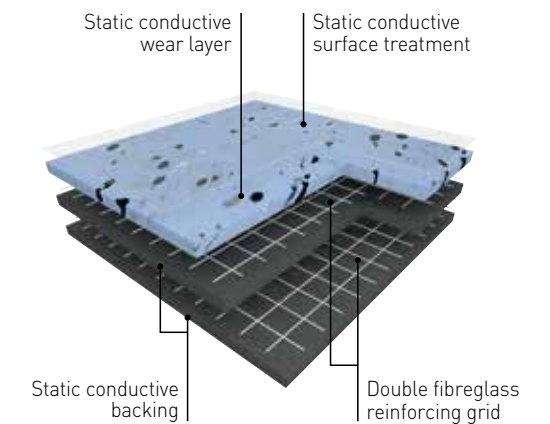

THE + FAST RENOVATION FLOORING SOLUTION FOR CLEANROOMS

EASY AND FAST INSTALLATION

- **Loose laid:** no glue
- **Easy to replace/repair**
- **Immediate return to production:** no adhesive curing time

SPECIFICALLY DESIGNED FOR CLEANROOMS

- **ISO5** according to ISO 14644-1
- **GMP - Class A** cleanrooms
- **Smooth surface**, easy to clean
- Can be hot welded to produce a **watertight system**
- **High resistance to chemicals**
- **Resistance to heavy traffic**

EX ADAPTED FOR EXPLOSIVE AREAS

- **Floor with static conductive properties**, if installed with a copper strip*

**In accordance with the corresponding Gerflor installation procedures*

GTI MAX CLEANTECH

- Alternatives for GMP - Class C/D cleanrooms (ISO 7)

CORNER SYSTEM

ISO and GMP standards require industries to have easy-to-clean and easy-to-decontaminate cleanrooms. Corners are specifically hard to maintain.

GERFLOR has developed an exclusive corner solution (patent pending), Clean Corner System, adapted to these requirements.



CLEAN CORNER SYSTEM

THE  CORNER SYSTEM FOR CONTAMINATION CONTROL IN CLEANROOMS

-  **EASY TO CLEAN AND DECONTAMINATE**
 - No acute angle
-  **WATERTIGHT**
 - Easy welding and strong solution
-  **RESISTANT AND DURABLE**
 - Reinforced support profile
-  **VERSATILE**
 - Can be used with flashcoving from 7 to 15 cm
-  **AESTHETIC**
 - Clean, attractive and uniform finish

BEFORE CLEAN CORNER SYSTEM



WALL PROTECTION

To maintain a clean work environment, walls and partitions must be protected against impacts that could quickly create tears and release particles into the air.

GERFLOR has pioneered an extensive range of wall protection solutions called SPM Decoclean and Mural Ultra in response to these different requirements.



SPM DECOCLEAN

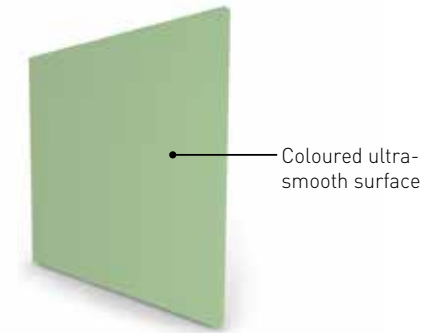

THE **+** ULTRA-RESISTANT WALL PROTECTION FOR CLEANROOMS



EASY TO CLEAN

- Ideal for repairing damaged walls (H₂O₂, impacts)
- Ideal for converting rooms with tiled or plasterboard walls into cleanrooms



HIGH RESISTANCE:

- Withstands impacts and shocks

BESPOKE OPTIONS:

- cut-outs, bends, chamfers (corners, door frames, etc.)
- door protection

MURAL ULTRA

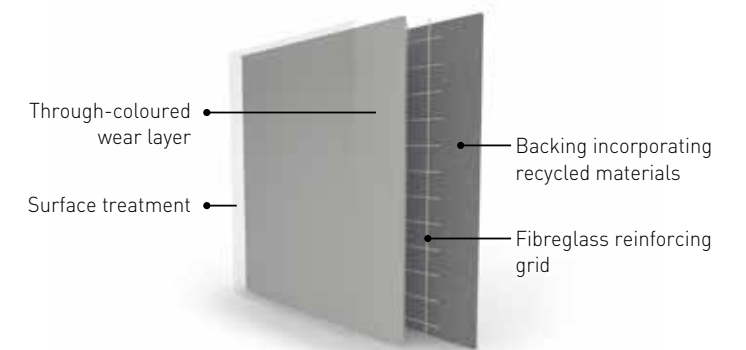

- Flexibility during installation
- High impact resistance
- Suitable for safe areas and grey areas

ESD AREA EPA/ATEX*

PROTECT AGAINST THE RISK OF
ELECTROSTATIC DISCHARGES

ESD PROTECTED AREA ⚠ ESD PROTECTED AREA ⚠ ESD PROTECTED AREA ⚠ ESD PROTECTED AREA ⚠

*ESD: ElectroStatic Discharge
EPA: ESD Protected Area
ATEX: Explosive or flammable atmosphere



YOUR REQUIREMENTS

- Control over electrostatic phenomena
- Moderate to heavy traffic
- Chemical attacks

OUR GLOBAL SOLUTION

1

ESD FLOORING

- Mipolam ESD range p.55
- **Renovation solutions:**
 - GTI EL5 Connect p.57
 - GTI EL5 CleanTech p.57

2

CUSTOM SOLUTION

- Logo p.92

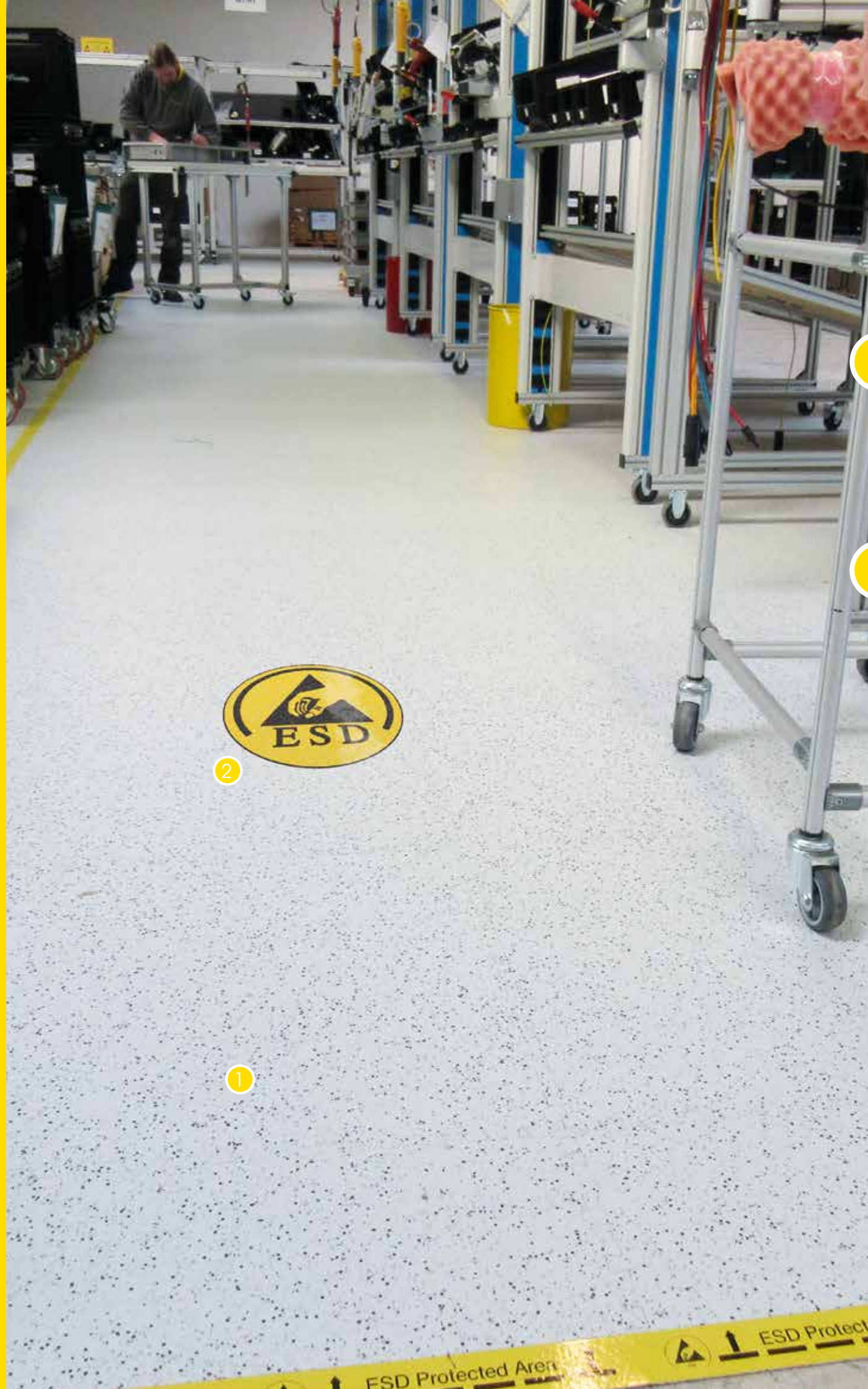

ESD FLOORING

In areas requiring protection against electrostatic discharges, measures must be taken to prevent and dissipate electric charges. Such measures allow for the manufacture of electrostatic-sensitive devices (ESDS devices) and can also be used to protect work environments featuring an explosive atmosphere due to the high concentration of particles or chemicals in the air.

GERFLOR produces ESD flooring to address these different requirements and keep ESD phenomena firmly under control.

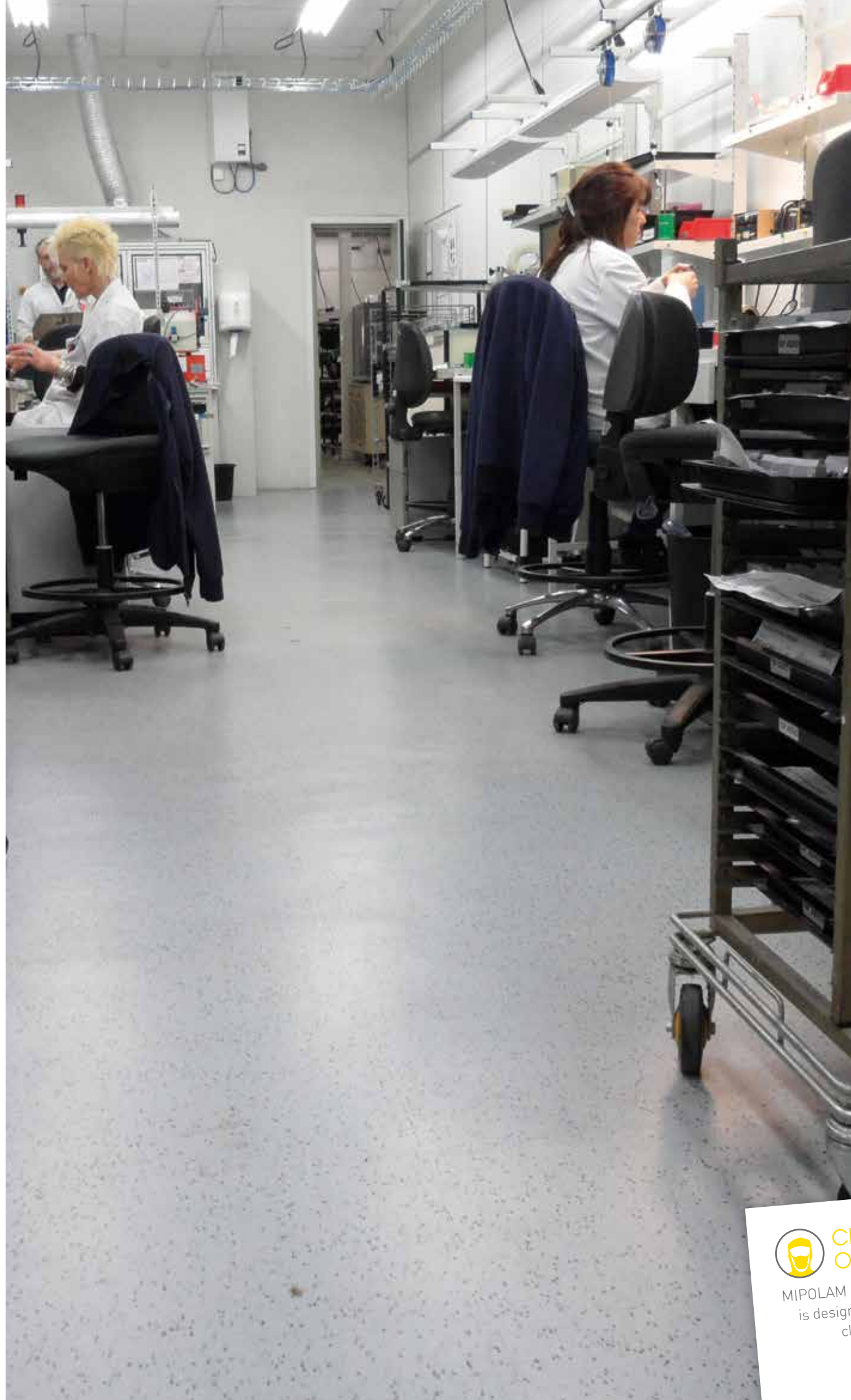

MIPOLAM ESD RANGE

MIPOLAM ELEGANCE EL5

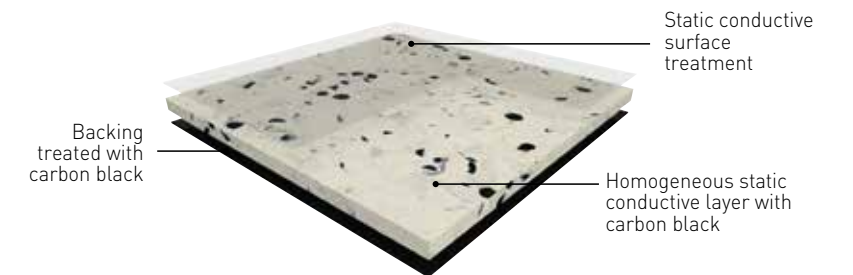

HIGH-PERFORMANCE FLOORING FOR ESD AREAS



CONTROL OVER ESD PHENOMENA

- Compliant with IEC 61340-5-1 & ESD S20.20
- Low charge potential
- High electrical resistance (Rt < 10⁶ Ω according to EN 1081)



DURABILITY

- Resistance to chemical attacks
- Resistance to traffic

MIPOLAM TECHNIC EL5

- Ideal for raised floors

MIPOLAM ACCORD EL7

- Dissipative flooring for ATEX areas
- Good electrical resistance (Rt < 10⁸ Ω according to EN 1081)



CLEANROOM OPTION

MIPOLAM BIOCONTROL EL5 is designed to be used in cleanrooms



ESD FLOORING

RENOVATION SOLUTIONS

WHY CHOOSE LOOSE-LAY FLOORING FOR RENOVATING YOUR ESD AREAS?

The subfloor is unsuitable for gluing

- Contaminated floor: presence of hydrocarbons...
- Damp floor slab
- Cracks or blisters (blow-moulded resin)
- Old floor covering

The renovation time must be reduced to a minimum

- Short production downtime
- Presence of heavy loads that quickly damage the floor

Reduce on-site pollution

- Dust-sensitive activities



GTI EL5 CONNECT

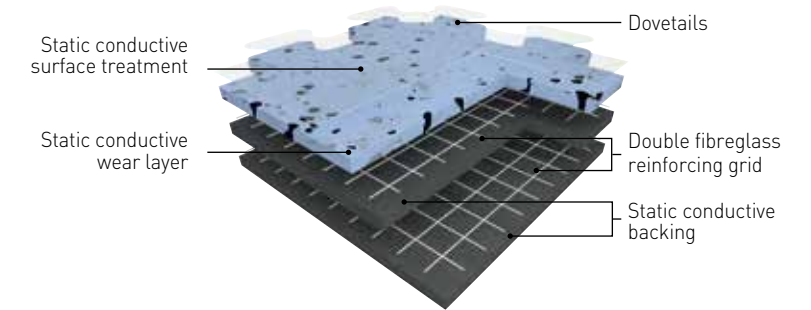

THE + NO DOWNTIME DURING INSTALLATION



QUICK AND EASY TO INSTALL

- Loose-lay design: no need to use adhesives
- Easy to replace / repair
- Installation while areas are in use: no production downtime
- Easy plug & play assembly with dovetails



DESIGNED TO MEET THE REQUIREMENTS OF THE ELECTRONICS INDUSTRY*

- Compliant with IEC 61340-5-1 & ESD S20.20
- Low charge potential
- High electrical resistance
- Resistance to chemical attacks
- Resistance to traffic

*Fitting according to the corresponding Gerflor installation guidelines

GTI EL5 LOGO

Clearly identify the area with the ESD logo (GTI EL5 Connect)



Code: 2724

GTI EL5 CLEANTECH

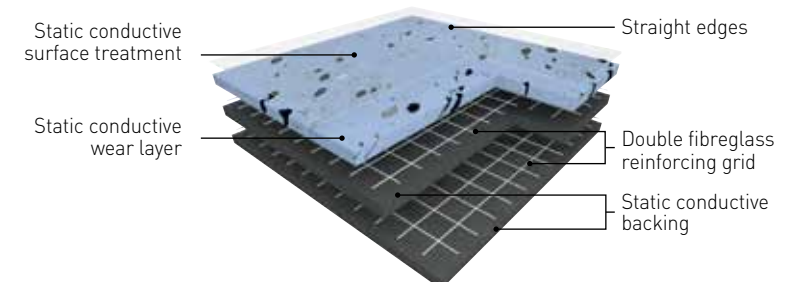

- A waterproof solution with hot-welded seams and skirting



Compatible with an in-situ installation on a raised floor



HEAVY traffic areas

FIT OUT YOUR BUSIEST AREAS



YOUR REQUIREMENTS

- Heavy and intensive traffic
- Repeated impacts and shocks
- Prolonged standing at work
- Regularly reconfigured workshops

OUR GLOBAL SOLUTION

1 FLOORING

- GTI Max Connect p.63

2 CUSTOM SOLUTION

- Logo p.92

3 WALL PROTECTION

- SPM Elasto p.65
- SPM Impact p.67
- SPM Cornea p.67
- SPM Decochoc p.69



FLOORING

Floors in heavy-traffic areas are severely put to the test with the frequent use of forklifts and trolleys, and the storage of heavy equipment. Furthermore, such areas are regularly reorganised to streamline production processes.

GERFLOR has developed the GTI Max Connect tile to withstand intensive traffic, while offering extremely quick and easy installation. Thanks to the Plug & Play jigsaw design, work areas can be reconfigured over and over again, and tiles can quickly be replaced in the event of an incident.

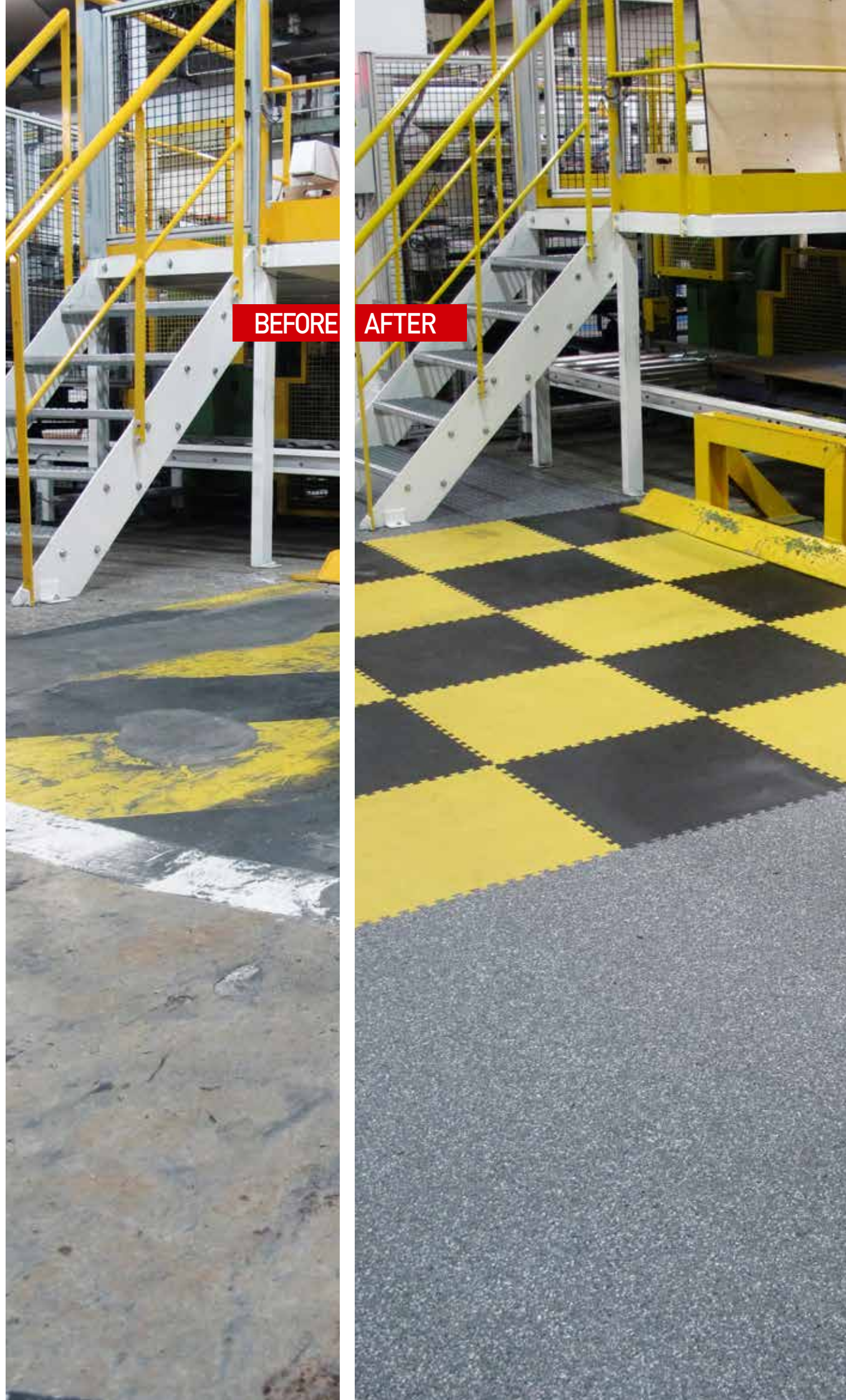

GTI MAX CONNECT

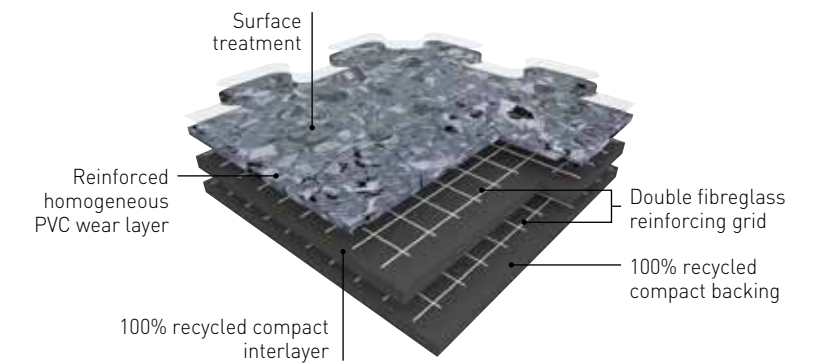

RUGGED & EASY TO INSTALL



RESISTANCE TO TRAFFIC

- Resistance to heavy and intensive traffic
- Robust installation with interlocking dovetails



QUICK AND EASY INSTALLATION

- No adhesives
- No curing time
- Can be installed on a subfloor that is unsuitable for gluing
- Tolerates small defects in the subfloor
- Replacements or modifications in the area without stopping work



COMFORTABLE WORKING CONDITIONS

- High non-slip properties to guarantee safety for employees
- Identification of the different circulation areas with several zoning possibilities and a wide choice of colours
- Flexible materials to provide comfort when standing at work



EASY MAINTENANCE

- Non-porous surface

GTI MAX LOGOS

- Improve zoning with our six logos, which offer the same advantages as GTI Max Connect



0001 Caution 0004 Stop 0003 Arrow 0002 Forklift 0005 No entry 0006 Pedestrian

HEAVY TRAFFIC AREAS



HEAVY TRAFFIC AREAS



WALL PROTECTION

Walls in heavy-traffic areas are severely put to the test with the frequent use of forklifts and trolleys, which invariably bump into the walls.

Gerflor developed the SPM Elasto range of angle brackets and bumpers to absorb and resist severe impacts in areas in which heavy and bulky carts are likely to circulate.

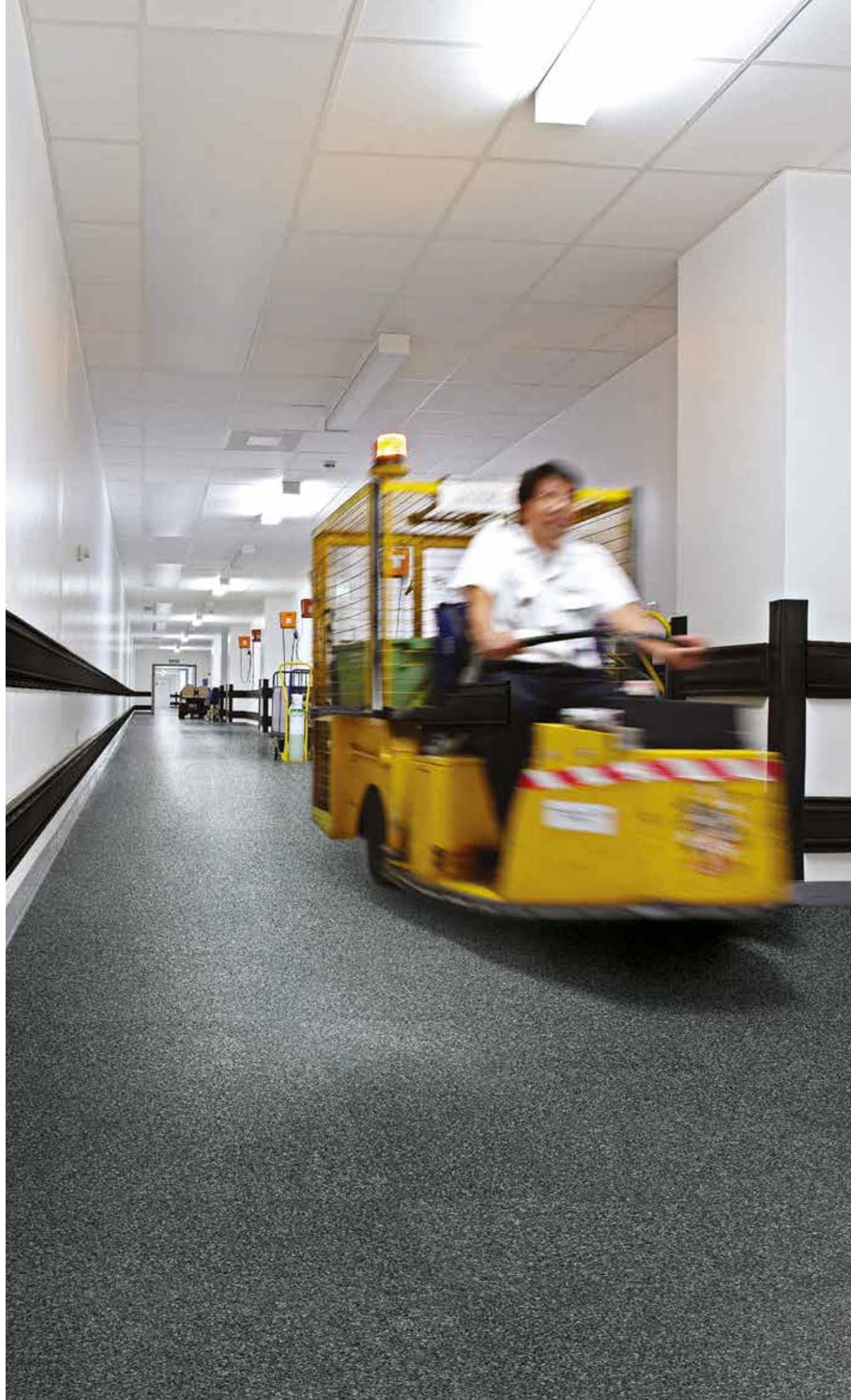

SPM ELASTO'PUNCH 200E



Bumpers (form E) in black thermoplastic elastomer

SPM ELASTO'PUNCH 100D



Bumpers (form D) in black thermoplastic elastomer

SPM ELASTO'FLEX 100V

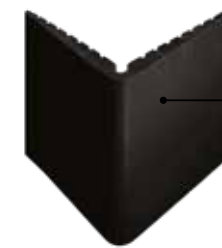

Flexible corner protector made of black thermoplastic elastomer



HIGH-RESISTANCE WALL PROTECTION



HIGH RESISTANCE

- High-density resistant elastomer
- Shock-absorbing effect
- For indoor and outdoor use



QUICK AND EASY INSTALLATION

HEAVY TRAFFIC AREAS



HEAVY TRAFFIC AREAS



WALL PROTECTION

Walls in heavy-traffic areas are severely put to the test with the frequent use of forklifts and trolleys, which invariably bump into the walls.

GERFLOR has pioneered SPM Impact bumpers to repel loads before they make contact with the wall.

GERFLOR has masterminded SPM Cornea corner protections to shield corners against impacts.



SPM IMPACT

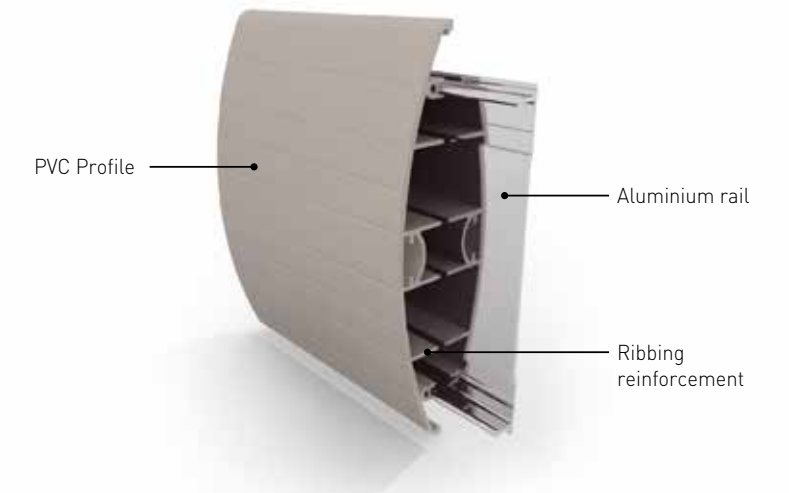

SPM CORNEA

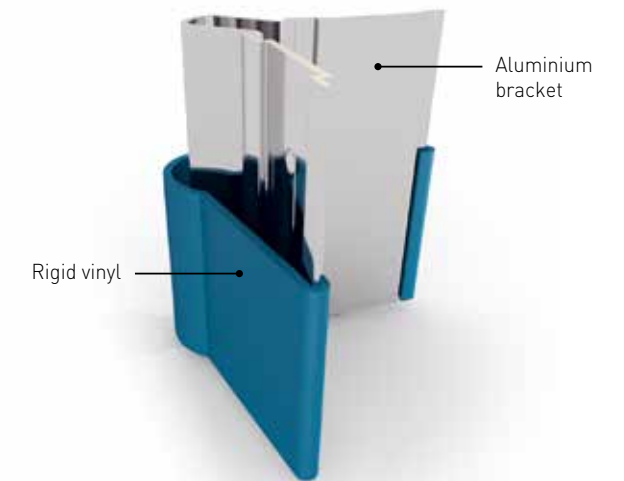

THE + RESISTANCE & AESTHETICS



RESISTANCE

- Resistant rigid vinyl
- Aluminium bracket
- Rounded shape to increase tear resistance



QUICK AND EASY INSTALLATION

- In the event of damage, the clip-on system allows the bumper to be replaced in just a few seconds



EASY MAINTENANCE

HEAVY TRAFFIC AREAS



HEAVY TRAFFIC AREAS



WALL PROTECTION

Walls in heavy-traffic areas are severely put to the test with the frequent use of forklifts and trolleys, which invariably bump into the walls.

GERFLOR has developed SPM Decochoc wall panels to withstand the most frequent impacts.



SPM DECOCHOC



THE + HIGH-RESISTANCE WALL PANELS



HIGH RESISTANCE

- Withstands impacts and shocks
- Resists scratches



EASY MAINTENANCE

BESPOKE OPTIONS:

- cut-outs, bends, chamfers (corners, door frames, etc.)



OFFICES

& administrative areas

CREATE A COMFORTABLE WORK ENVIRONMENT FOR YOUR EMPLOYEES



YOUR REQUIREMENTS

- Eye-catching work environment
- Moderate traffic

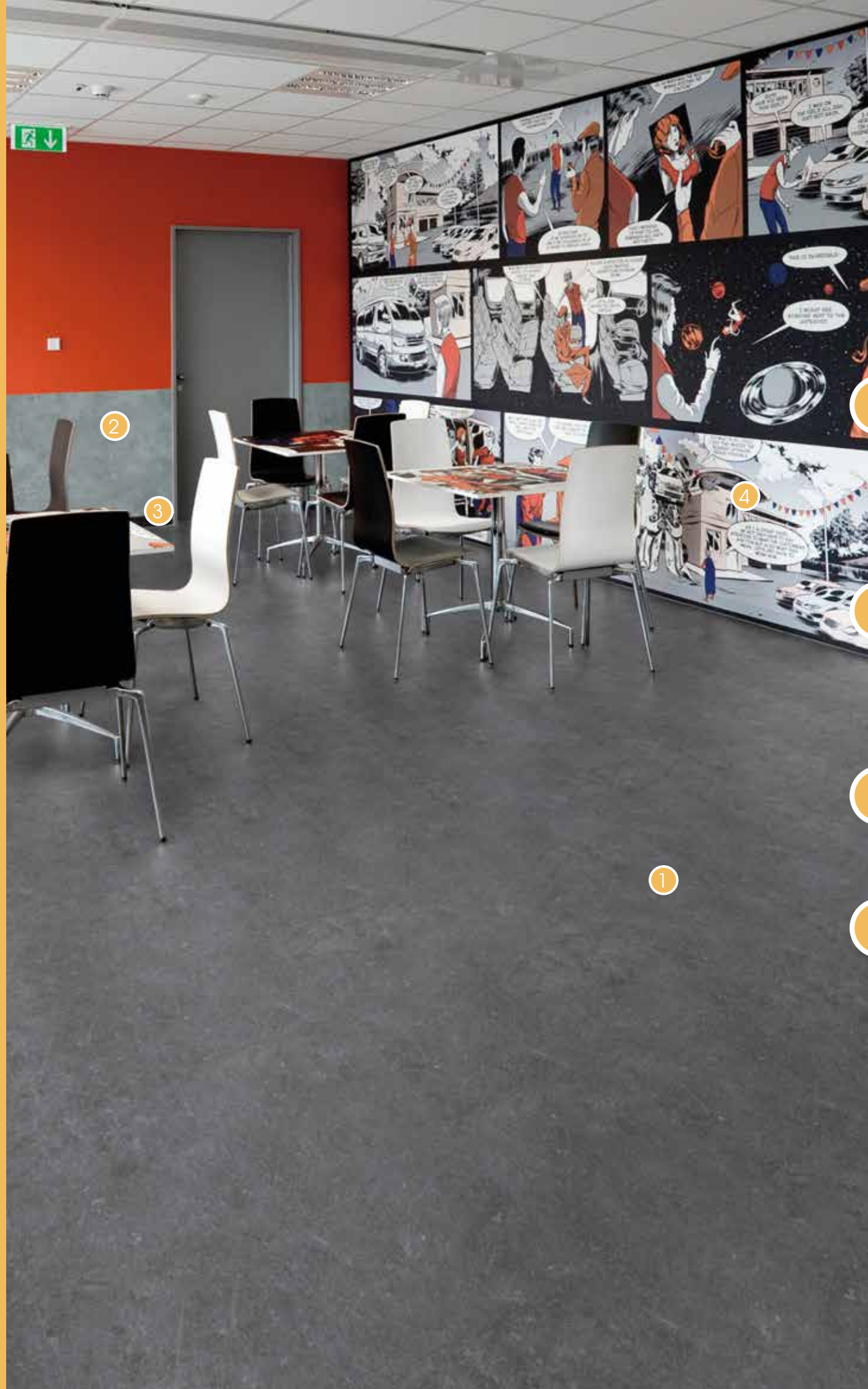

OUR GLOBAL SOLUTION

FLOORING

- Creation 70 p.75
- Taralay Impression Compact p.75
- **Renovation solutions:**
Creation 70 Clic System p.77

WALL PROTECTION

- SPM Decotrend p.79
- SPM Profila p.81
- SPM Contact p.83

FINISHES

- Design skirting p.77

CUSTOM SOLUTION

- SPM Decoprint p.93



FLOORING

Offices and administrative areas are subject to moderate levels of traffic. The flooring plays an important role in ensuring an effective work environment.



GERFLOR has developed a broad array of flooring to create a wide range of environments.

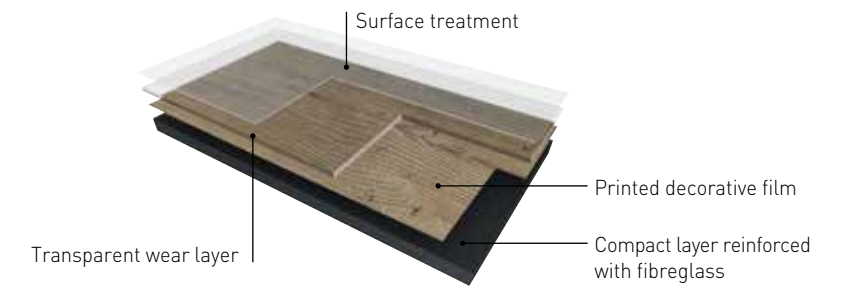

CREATION 70





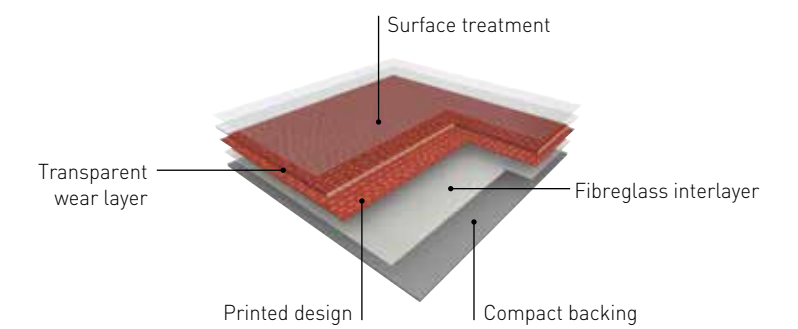

THE + AN ULTRA-NATURAL FINISH

-  **DURABILITY**
 - Resistance to traffic
 - Resistance to wear and water
-  **EYE-CATCHING**
 - High-end decorative effect: **Wood and Mineral**
 - Infinite layout possibilities
 - Matching skirtings
-  **CARE**
 - Surface treatment: easy maintenance

TARALAY IMPRESSION COMPACT



THE + DECORATIVE FINISH & QUICK INSTALLATION

-  **FAST**
 - Produced in rolls for quick installation
-  **EYE-CATCHING**
 - Innovative finishes and bright colours
-  **DURABILITY**
 - Resistance to traffic
-  **CARE**
 - Surface treatment: easy to maintain and never any need for self-shine treatment

FLOORING RENOVATION SOLUTIONS

WHY CHOOSE LOOSE-LAY FLOORING FOR REFURBISHING YOUR OFFICES?

The subfloor is unsuitable for gluing

- Contaminated floor: presence of asbestos...
- Damp floor slab
- Cracks or blisters
- Old floor covering

The renovation time must be reduced to a minimum

- Reduce office downtime

Reduce on-site pollution

- No major cleaning required after installation
- No adhesive odours



BEFORE



AFTER

CREATION 70 CLIC SYSTEM

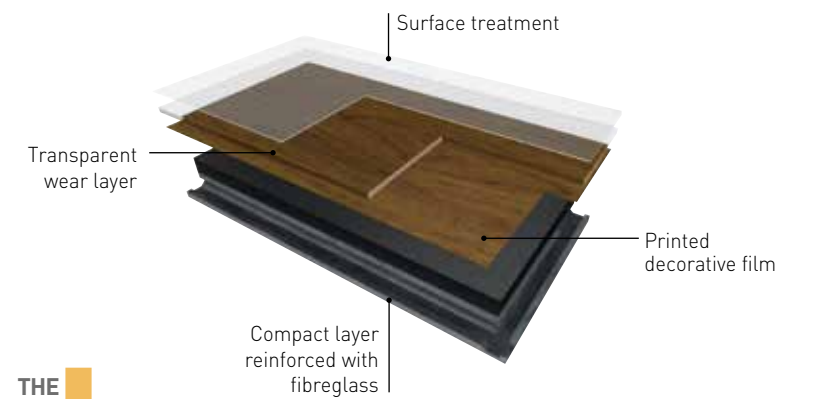

REFURBISH YOUR OFFICES QUICKLY AND EASILY



QUICK AND EASY INSTALLATION

- No adhesives
- No curing time
- Can be installed on a subfloor that is unsuitable for gluing
- Replacements or modifications in the area without stopping work
- Easy doorways without any thresholds



EYE-CATCHING

- High-end decorative effect
- Matching skirtings



EASY MAINTENANCE



ASBESTOS SOLUTION

- Suitable for renovating asbestos floors

DESIGN SKIRTING

- Matching design with Creation range



SAFE'CAP

- Drilling capsule for asbestos floors



Compatible with an in-situ installation on a raised floor

WALL PROTECTION

Office walls are prone to impacts (chairs, circulation, etc.).

GERFLOR has developed SPM Decotrend panels to protect walls while providing a modern decorative effect.



SPM DECOTREND



THE + EYE-CATCHING WALL PROTECTION

- EYE-CATCHING**
 - Ultra-realistic wood and metal effects
- PROTECTION**
 - Impact resistance
 - Scratch resistance



WALL PROTECTION

Office walls are prone to impacts (chairs, circulation, etc.).

GERFLOR has developed SPM Profila corner protections to shield wall corners against such impacts.



SPM PROFILA

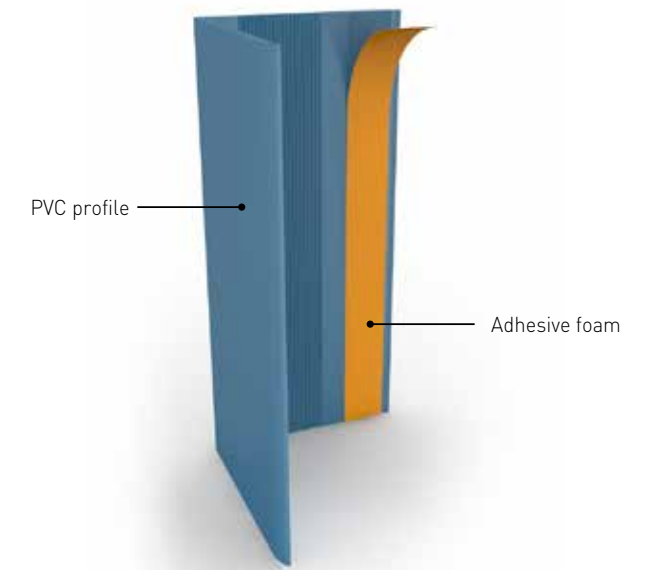

THE + HIGH RESISTANCE CORNER PROTECTION



HIGH RESISTANCE

- Ultra-resistant rigid vinyl
- Aluminium bracket
- Rounded shape to increase tear resistance



QUICK AND EASY INSTALLATION WITH PRE-INSTALLED ADHESIVE STRIPS

- In the event of damage, the clip-on system allows the corner protection to be replaced in just a few seconds



EASY MAINTENANCE



WALL PROTECTION

Office walls are prone to impacts (chairs, circulation, etc.).

GERFLOR has developed SPM Contact bumpers to protect walls and doors against such impacts.



SPM CONTACT

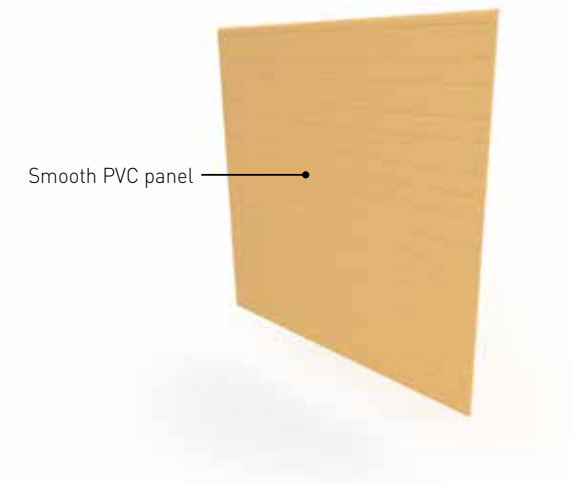

THE + LOW-PROFILE BUMPERS



HIGH RESISTANCE

- Ultra-resistant rigid vinyl
- Rounded shape to increase tear resistance



QUICK AND EASY INSTALLATION

- Affixed using pre-installed adhesive strips



EASY MAINTENANCE



SERVICES

GERFLOR: ONE-STOP SUPPORT
FOR ALL YOUR PROJECTS





VALIDATION OF CHEMICAL RESISTANCE

Before choosing a flooring, it is important to list the chemicals that may come in contact with the flooring and walls (cleaning and disinfection products, liquids that may be spilled, etc).

- Results against commonly used chemicals available upon request.
- Our lab can analyse new chemicals upon request.
- GERFLOR can send samples for internal testing at customer's testing according EN 423.



SHOWROOMS

It is never easy arranging a visit to places where our products have been installed. Therefore, GERFLOR has built complete showrooms with leading industry partners to show you its solutions in real-life conditions.

They provide a clearer insight into our different solutions for each area, including a set of ISO 7 cleanrooms spanning over 300 sqm.

Feel free to contact your sales manager to arrange a visit to help move your project forward.



RECOMMENDED INSTALLATION COMPANIES

We have drawn on our extensive track record in technical installations to select reliable and skilled installation companies to fit our products on your premises.



TECHNICAL SUPPORT

● PROJECT INITIATION

A technical crew is ready and waiting to help you get your project off the ground (subfloor inspection, installation of the floor covering, and so on), as well as deliver expertise and provide training for your installation teams at the GERFLOR Technocentre.

● TECHNOCENTRE GERFLOR

GERFLOR has built several Technocentres all around the globe to organise technical trainings for skilled and experienced installers.





MYFLOOR CUSTOM FLOOR SOLUTIONS

With several years' experience in water jet cutting technologies, we can **customise the flooring design** for your future projects:

Send us your designs and we will take care of the rest!

MYLOGO

What about your company's logo or other signage? Anything is possible...



MYDESIGN

Create a unique mood in your work environment by combining different shapes and floor colours.



MYCOLOUR

Planning a large-scale project?

Personalise your flooring by choosing from **150 colours** to create over **400,000 combinations** and a unique design!

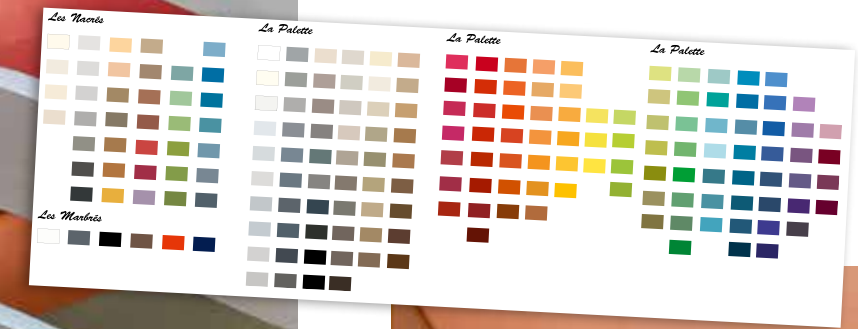

MYWALL

CUSTOM WALL SOLUTIONS

● SPM DECOPRINT

A wall protection that expresses your imagination.

We produce your **custom-designed protective panel** using a print of your visual in the required dimensions.

This is the ideal protection for adding a touch of sophistication and originality to your work areas with an aesthetic combination of signs and markings.



Vinyl with an image printed on the back thickness 1 or 2 mm

● SPM DECO CARE

Decocare hand hygiene panels combine a public health message with effective protection of the walls above sinks.

The educational pictograms are easy to understand and encourage good hand hygiene in order to limit the spread of hand-borne germs.

The panels provide **attractive wall protection** and can be installed in all wet rooms to spell out the hand washing routine. They can also be customised with your logo or other text.

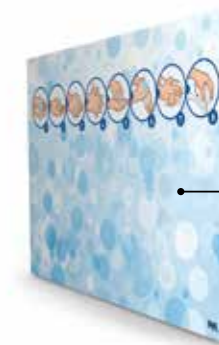

Vinyl with an image printed on the back thickness 1 mm



WATERTIGHTNESS CONTROL

A UNIQUE AND INNOVATIVE SYSTEM TO CHECK THE INTEGRITY OF GERFLOR FLOORING...

The Watertightness Control System is an installation technique specifically designed for GERFLOR flooring, which tests the quality of the hot welds and the integrity of the installed surfaces.



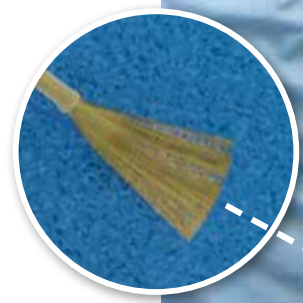

... DEVELOPED TO SATISFY USERS' REQUIREMENTS

The Watertightness Control System has been tested and specified by the largest laboratories in the pharmaceutical industry.

It is designed to fully satisfy the hygiene and microbial decontamination recommendations specified in the GMP guide.



THE +

- 
Validation
 The quality of the installation and the seal tightness of the flooring is checked before commissioning.
- 
Reliability
 Periodic checks of the integrity of the flooring during service stoppages.
- 
Quality
 Any defects are repaired before commissioning. Any moisture-related problems are identified.
- 
Decontamination
 Prevents a contamination zone from forming.



4 STEP VALIDATION

1 Connect the tester

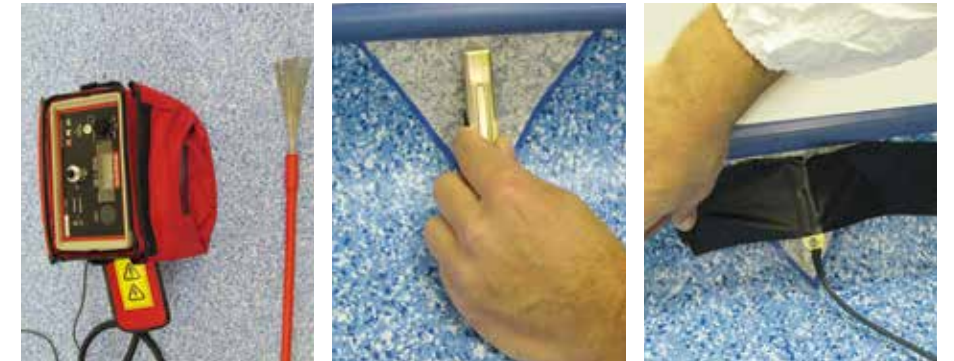

2 Check the welds



Electric arc + warning sound = defect

3 Check the surfaces

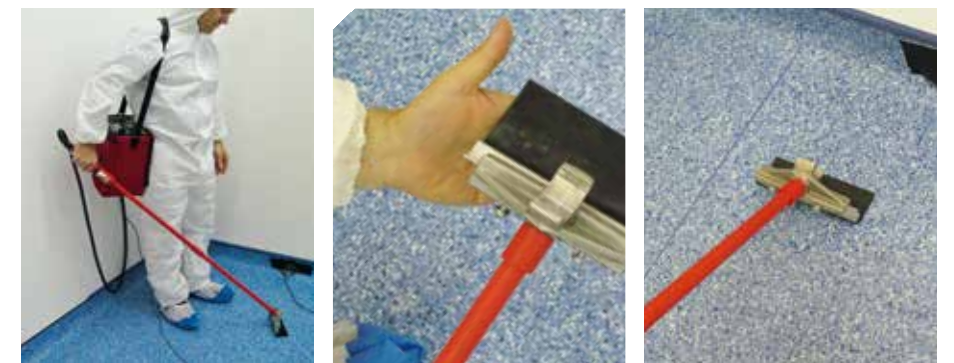

4 Do any repairs and a final test

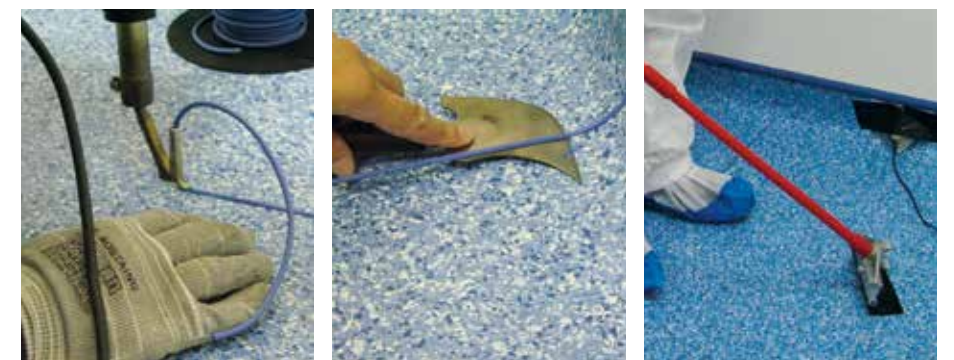

GERFLOR INTERNATIONAL (Other countries)
Tel: +33 (0)4 74 05 40 00 - Fax: +33 (0)4 74 05 03 13
e-mail: industry@gerflor.com

ASIA: Gerflor Asia
Tel: +852 9222 6355 - Fax: +852 3006 1449
e-mail: gerflorasiasa@gerflor.com

AUSTRALIA/NEW ZEALAND: Gerflor Australasia Pty. Ltd
Australia Tel: 1 800 060 785 - New Zealand Tel: 0 800 630 119
e-mail: gerflor@gerflor.com.au

AUSTRIA/SWITZERLAND: Gerflor GmbH
Tel: +43 (0)72 29/70 800-0 - Fax: +43 (0)72 29/70 800-218
e-mail: austria@gerflor.com - switzerland@gerflor.com

BELGIUM/LUXEMBURG: Gerflor Benelux
Tel: +32 (0)3 766 42 82 - Fax: +32 (0)3 766 29 14
e-mail: gerflorbel@gerflor.com

CANADA: Gerflor International
Tel: +1 438 333 0752 - Fax: +1 438 380 5425
e-mail: gerflorcanada@gerflor.com

CHINA: Gerflor floorings (China) Co. Ltd.
Tel: +86 21 6357 8818 - Fax: +86 21 6357 8998
e-mail: gerflorchina@gerflor.com

FINLAND: Gerflor Oy
Tel: +358 (0) 10 6 17 5150 - Fax: +358 (0) 10 6 17 5152
e-mail: info@gerflor.fi

FRANCE: Gerflor - Service Express:
 
e-mail: contactfrance@gerflor.com - industry@gerflor.com

GERMANY: Gerflor Mipolam GmbH
Kunden-Service
Tel: +49 (0) 22 41-25 30-136 - Fax: +49 (0) 22 41-25 30-100
e-mail: kundenservice@gerflor.com

IRELAND: Gerflor Ltd
Tel: +353 (0) 42 966 1431 - Fax: +353 (0) 42 966 1759
e-mail: gerflorirl@gerflor.com

ITALY: Gerflor S.p.A.
Tel: +39 02 90 40 10 - Fax: +39 02 90 42 74 84
e-mail: gerfloritalia@gerflor.com

LATIN AMERICA (Brazil): Gerflor América Latina
Tel: +55 11 38 48 20 20
e-mail: gerflor@gerflor.com.br

MIDDLE EAST: Gerflor Middle East
Tel: +966 13 847 1779 - Fax: +966 13 847 1781
e-mail: info@gerflorme.com

NETHERLANDS: Gerflor Benelux
Tel: +31 (0)40 266 17 00 - Fax: +31 (0)40 257 46 89
e-mail: gerflornl@gerflor.com

POLAND: Gerflor Polska Sp z o.o.
Tel: +48 61 823 34 01 - Fax: +48 61 823 34 33
e-mail: info@gerflor.pl

PORTUGAL: Gerflor Iberia, SA
Tel: +351 21 843 95 49 - Fax: +351 21 846 55 44
e-mail: gerflorportugal@gerflor.com

RUSSIA: Gerflor zao
Tel./Fax: +7 495 785 23 71
e-mail: gerflorussia@gerflor.ru

SCANDINAVIA: Gerflor Scandinavia a.s.
Tel: +47 64 95 60 70 - Fax: +47 64 95 60 80
e-mail: gerflorscand@gerflor.no

SPAIN: Gerflor Iberia, SA
Tel: +34 91 653 50 11 - Fax: +34 91 653 25 85
e-mail: gerfloriberia@gerflor.com

UNITED KINGDOM: Gerflor Ltd
Sample service: contractuk@gerflor.com
Office Tel: +44 (0) 1926 622 600 - Fax: +44 (0) 1926 401 647

USA: Gerflor North America
Tel: 877 GERFLOR (437 3567) - Fax: 847 394 3753
e-mail: info@gerflorusa.com

industrybygerflor.com
industry@gerflor.com

ARCHITECTURE
DECORATION
SPORT
TECHNOSPECIFIC

Gerflor. Be CONNECTED!



Follow us on LinkedIn



industrybygerflor.com

GERFLOR, ECO-RESPONSIBLE SOLUTIONS



COMPOSITION
100% REACH compliant
FREE of formaldehyde
FREE of heavy metals
FREE of solvent



RECYCLED CONTENT
25% average recycled content
100% REACH compliant recycled content



RECYCLABILITY
100% recyclable product



INDOOR AIR QUALITY
TVOC emissions between 10 and 100 times better than norms requirements
Floorscore certified
No formaldehyde emission



INSTALLATION
Innovative adhesive free installation systems



LCA
- Eco-designed according to a product specific Life Cycle Analysis
- Product specific EPD (Environmental Products Declaration) available
- Manufactured in an Iso 14001 and Iso 50001 certified site
- Contribution to many Green Building Schemes (LEED, HQE, BREEAM...)



WELLNESS
Health: Antibacterial activity (inhibits growth > 99%)
Safety: Anti slip performance
Comfort: Walking comfort and impact noise reduction

Gerflor
theflooringgroup